

PANELSAFE PS RANGE

PS-150 INSTALLATION GUIDE

PS-150 PanelSafe Restraint System

PS-150



USE WITH:

PC Standard Range
LP Low Profile Range
VL Very Low Profile Range
MC Metal Range

INSTALL WITH:

CP-01ST CT-01 CT-09 CT-07 CT-03 CT-10

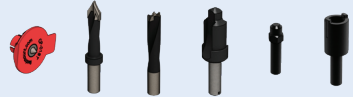

INSTALLATION STEPS Page 1

- 1** Drill hole through panel and frame

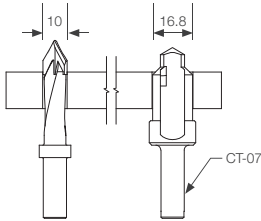

- 2** Screw PanelSafe in 16.8Ø hole

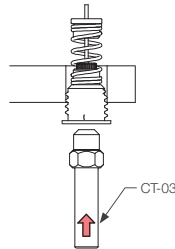

- 3** Fit CP-01ST into PanelSafe to mark panel

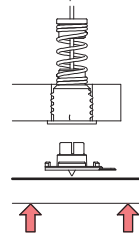

- 4** Drill panel on center mark
7.5mm deep

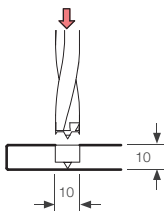

- 5** Screw fit PS-M with CT-10

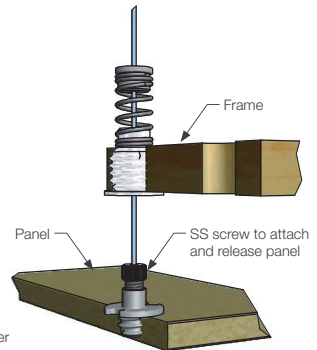
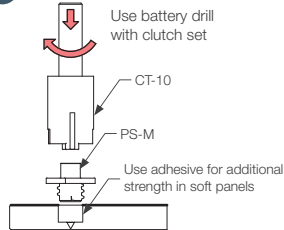

- 6** Completed installation

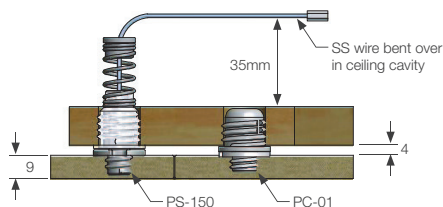

PANELSAFE PS RANGE

PS-150 INSTALLATION GUIDE

PS-150 PanelSafe Restraint System

PS-150



USE WITH:

PC Standard Range
LP Low Profile Range
VL Very Low Profile Range
MC Metal Range

INSTALL WITH:

CT-03 CT-10



INSTALLATION STEPS Page 2

- A** Plan view of panel from above with 4 x PanelSafe
 Larger or more flexible panels may require extra PanelSafes for correct support. Each PanelSafe has a static load of 150kgs and a drop load of 10kgs.

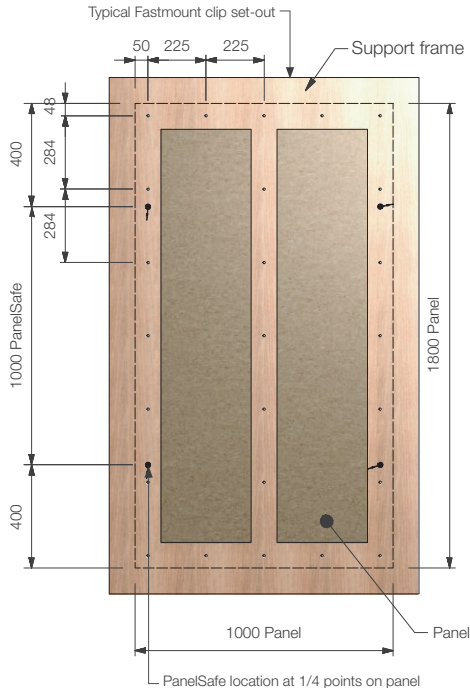

- B** End view with panel down



- C** End view with panel down

